



BRIDGE TRIPOD TURNSTILE MT141

MT141 tripod turnstiles have three rotating arms that block or allow passage when activated. These arms rotate in one direction and typically return to their default position after each use. The blocking and releasing are achieved by rotation. Tripod turnstiles are commonly used in a variety of settings to enhance security, manage access, and prevent unauthorized entry.

Tripod turnstiles can be configured for uni-directional or bi-directional use. In uni-directional mode, they permit passage in only one direction, while in bi-directional mode, they allow entry and exit through the same access control tripod turnstile.

Tripod turnstile features lights and audible signals to inform users whether access is granted or denied, promoting smooth and efficient passage.

Tripod turnstiles are made of sturdy materials such as 304 stainless steel and they are durable and resistant to wear and tear, even in high traffic areas.



PASSING SPEED



BI-DIRECTION

110V-220V
POWER SUPPLY

ANTI-TAILGATING



PROTECTIVE LEVEL

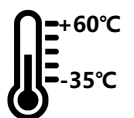

TEMPERATURE RANGE

Technical Specifications

Dimension	1400*280*980mm (4.59*0.92*3.22ft) (standard)
Passage Width	550mm (1.80ft) (standard)
Arm Length	510mm (1.67ft)
Frame Material	304 stainless steel and powder coated (standard), 316 stainless steel
Mechanism	Semi-automatic
Pass rate	30-40 person/min
Power Supply	100V-240V 50/60Hz
Drive Solenoid	DC 24V
Open Signal	Passive Relay (Dry Contact)
Communication	RS485
Working Direction	Bi-directional(standard), Unidirectional
Emergency	Automatic drop arm after power failure
Working Temperature	-35°C ~ 60°C
Working Environment	Indoor and outdoor
Relative Humidity	95% Maximum

Feature

- **LED ALERTS** The front LED will keep green shows that the lane is available. If the lane is not available, it will turn red.
- **EMERGENCY EXIT** Functionality allows free passage in the event of an emergency. The arm will drop off when power outage. Manually reset when power is restored.
- **WORKING DIRECTION** Single directional or Bi-directional are optional.
- **AUTOMATIC RESET** Arms will lock automatically within 5s (adjustable) if a person delay to access.
- **ANTI-PASS BACK** The turnstile will stay in lock if someone wants to entry in the reverse direction.
- **ANTI-INTRUSION** the gate is locked automatically until a valid open signal is sent.
- **FAST UNLOCK** One there is a valid signal, the gate will unlock within 0.2s (adjustable).
- **HYDRAULIC DAMPER** Equipped with a hydraulic shock absorber for less noise during operation.
- **MOLD DESIGN** The mechanism is mold design. The components are more precise. It can save more labor cost and easier to assemble.

Access control system

Our gates come with relay signals and RS485/RS232 interfaces. You can use your own access control system, or we can provide a complete access control system to you.

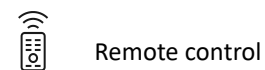

Remote control



RFID card



QR code/ barcode



Counter



Face recognition



Fingerprint recognition



Coin/ Card collection



Button

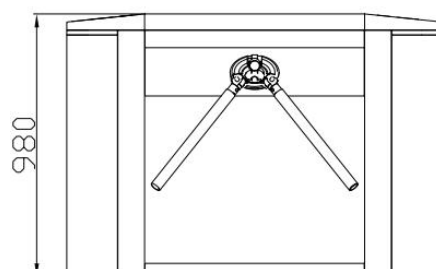
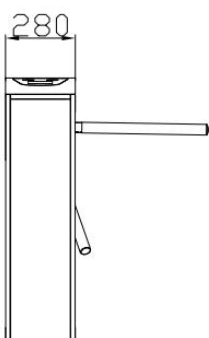
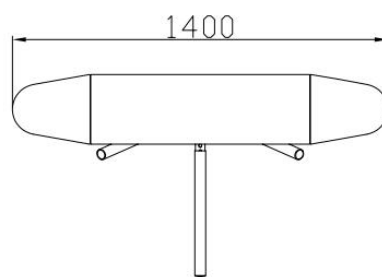
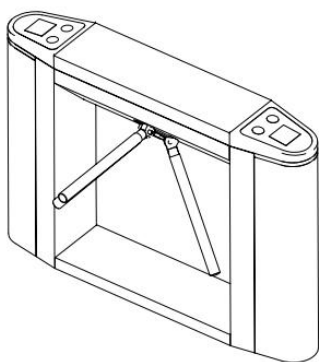

Customization

- Dimension: Can be made according to the client's site.
- The semi-automatic mechanism can be replaced with a fully automatic mechanism.
- Material: 304 stainless steel to 316 stainless steel (wet environment), or iron with powder coated. The outer paint finish can be colour coated to match the local environment.
- LED lights can be added.
- Mounting base can be added.
- Cutouts can be customized to fit any reader.
- LOGO can be customized.
- Customized 3D drawings are available based on the site photos.
- OEM& ODM service is available.

➤ Please check with sales for customization fees.

We also offer customization services.



Cutouts can be customized to fit any reader.

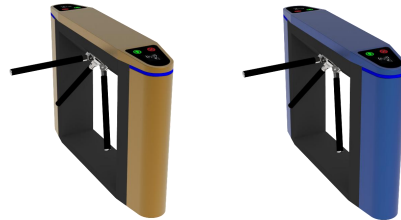

Other colors available, RAL or RGB required.

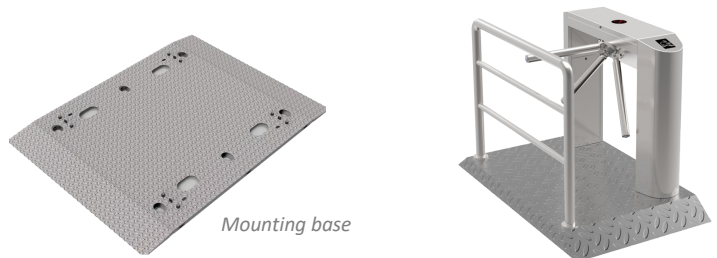

Mounting base

