



## FLAP TURNSTILE MT253

**MT253 flap turnstile** is a type of access control device used to manage pedestrian flow in secure areas. It consists of retractable flaps that act as barriers, allowing only authorized individuals to pass through while preventing unauthorized access. The flap turnstile is a security solution commonly found in areas where controlled entry is essential, such as public transportation stations, office buildings, stadiums, and more.

MT253 mobile flap turnstile provides bi-directional and unidirectional access control and free passage modes. In access control mode, upon receipt of a valid card signal from an access control system, the motorized barrier flap of the turnstile quickly retract into the cabinet, and the integrated sensors allow a single user to pass through the turnstile in the requested direction. The front post LED will keep green shows that the lane is available. The top LED will change based on the status of the gates.



PASSING SPEED



PASSAGE FOR DISABLE



BI-DIRECTION



110V-220V  
POWER SUPPLY



ANTI-TAILGATING



IP<sub>41</sub>  
PROTECTIVE LEVEL

# Technical Specifications

Dimension	1400*300*1000mm (4.59*0.98*3.28ft) (standard)
Passage Width	550mm (1.80ft)
Pass Rate	40 person/min
Mechanism	Full height mechanism with DC motor
IR sensor	5 pairs
Frame Material	SUS304 and powder coated
Flap arm Material	Acrylic Flap
Power Supply	100V-240V, 50/60Hz
Open Signal	Passive Relay (Dry Contact)
Communication	RS485/RS232
Working Direction	Bi-directional(standard), Unidirectional
Working Temperature	-35°C ~ 60°C
Working Environment	Indoor or outdoor
Relative Humidity	95% Maximum

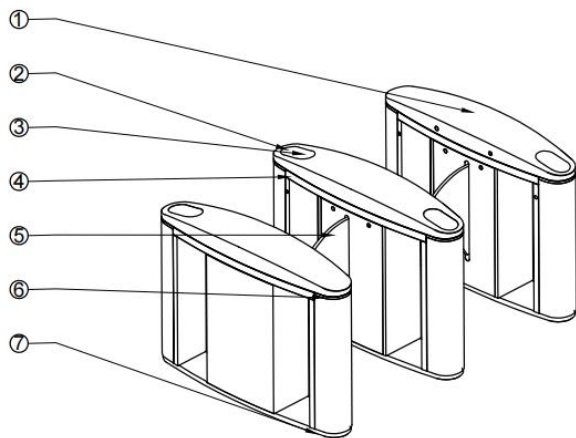

- ① Stainless Steel Top Lid
- ② Acrylic CARD Window
- ③ Direction Indicator
- ④ IR Sensor Cover
- ⑤ Acrylic Flap Arm
- ⑥ Lane Status Indicator
- ⑦ Position of Fixing Screw

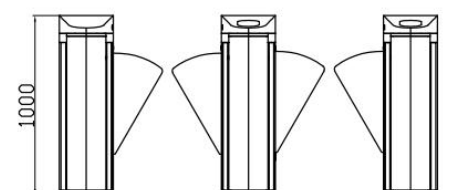
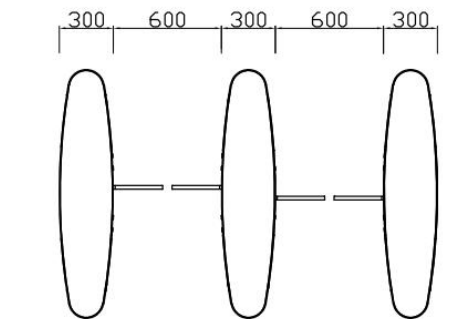
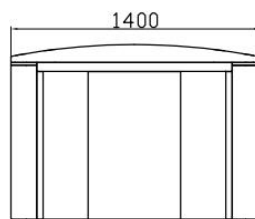

# Feature

- **LED ALERTS** Indicate traffic direction with highly-visible green and red. The front post LED will keep green shows that the lane is available.
- **EMERGENCY EXIT** The function allows free passage in the event of an emergency or power outage, automatic reset when power is restored.
- **WORKING DIRECTION** Single directional or Bi-directional is optional.
- **AUTOMATIC RESET** The flap arms will lock automatically within 5s (adjustable) if a person delay to access.
- **ANTI-PASS BACK** The gate will stay in lock if someone wants to entry in the reverse direction.
- **ANTI-INTRUSION** The gate is locked automatically until a valid open signal is sent.
- **FAST UNLOCK** One there is a valid signal, the gate will unlock within 0.2s (adjustable) .
- **HIGH PERFORMANCE** Long-life performance, high operation dependability and fast response.
- **HIGH MECHANISM** Full height mechanism, running smoothly and stable
- **ALARM FUNCTION** Infrared sensor alarm function, in case of illegal intrusion and reverse intrusion.

# Customization

- Dimension: Can be made according to the client's site.
- Optional dual-layer retractable flap arm with a passing width of up to 900 mm (for wheelchairs and luggage).
- Flap arm color: Transparent color, blue and red available.
- Material: 304 stainless steel to 316 stainless steel (wet environment), or iron with powder coated (color can be customized).
- Lights and infrared sensors can be added.
- Mounting base (for above floor wiring) and removable base (for temporary events) can be added.
- Cutouts can be customized to fit any reader.
- LOGO can be customized.
- Customized 3D drawings are available based on the site photos.
- OEM& ODM service is available.

➤ Please check with sales for customization fees.

# Access control system

Our gates come with relay signals and RS485/RS232 interfaces. You can use your own access control system, or we can provide a complete access control system to you.

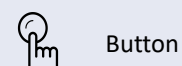
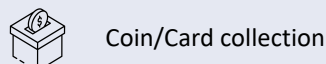
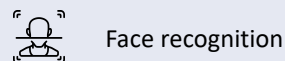
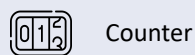
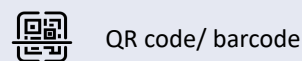
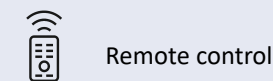

## We also offer customization services.

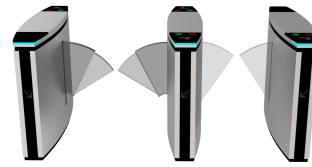

Dual-layer retractable flap arms



Blue flap arms

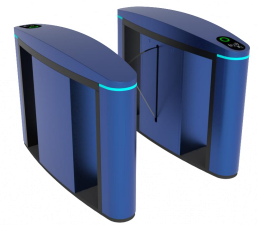
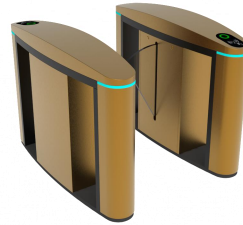

Other frame colors available, RAL or RGB required.



Mounting base

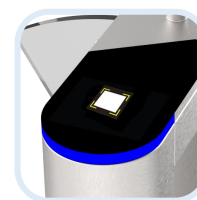
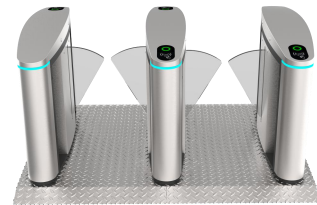

Cutouts can be customized to fit any reader.



LOGO can be customized.



# Emergency mode



Powered of equipment  
with Super Capacitor Backup

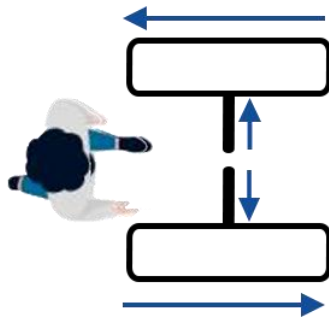

In case of a power outage,  
obstacles are unlocked  
and automatically open in  
the direction of egress.



Obstacles are locked in  
the open position so as  
not to interfere with the  
evacuation process.

# Lane combination



One lane



Two lanes



Three lanes

