

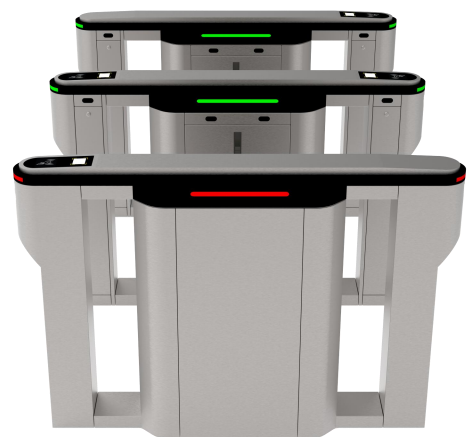

FLAP TURNSTILE MT261

MT261 flap turnstile is a type of access control device used to manage pedestrian flow in secure areas. It consists of retractable flaps that act as barriers, allowing only authorized individuals to pass through while preventing unauthorized access. The flap turnstile is a security solution commonly found in areas where controlled entry is essential, such as public transportation stations, office buildings, stadiums, and more.

MT261 flap turnstile gate provides bi-directional and unidirectional access control and free passage modes. In access control mode, upon receipt of a valid card signal from an access control system, the motorized barrier flap of the turnstile quickly retract into the cabinet, and the integrated sensors allow a single user to pass through the turnstile in the requested direction. There is LED light on the flap arms. In standby, the LED is in blue. When open, the LED turns to green. When illegal access, the LED turns to red and keep flash.

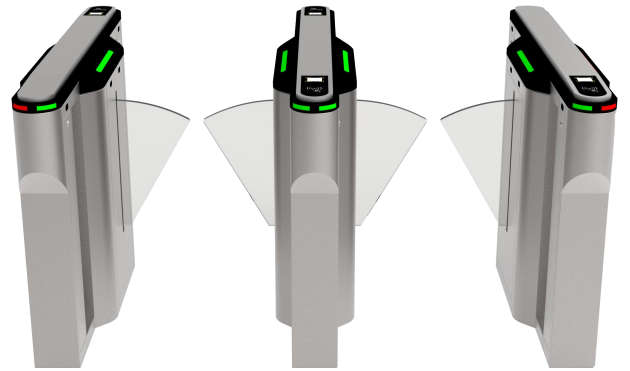

PASSING SPEED



PASSAGE FOR DISABLE



BI-DIRECTION



110V-220V
POWER SUPPLY



ANTI-TAILGATING



IP₄₁
PROTECTIVE LEVEL

Technical Specifications

Dimension	1500*300*980mm (4.92*0.98*3.22ft) (standard)
Passage Width	550mm (1.80ft) -600mm(1.97ft)
Pass Rate	35-45 person/min
Mechanism	Full height mechanism with DC motor
IR sensor	5 pairs
Frame Material	SUS304 and powder coated
Flap arm Material	Acrylic Flap with LED
Power Supply	100V-240V, 50/60Hz
Open Signal	Passive Relay (Dry Contact)
Communication	RS485/RS232
Working Direction	Bi-directional(standard), Unidirectional
Working Temperature	-35°C ~ 60°C
Working Environment	Indoor
Relative Humidity	95% Maximum

Feature

- **LED ALERTS** Indicate traffic direction with highly-visible green and red. The front post LED will keep green arrow shows that the lane is available. The LED on the side will change based on the status of the gates.
- **EMERGENCY EXIT** The function allows free passage in the event of an emergency or power outage, automatic reset when power is restored.
- **WORKING DIRECTION** Single directional or Bi-directional is optional.
- **AUTOMATIC RESET** The flap arms will lock automatically within 5s (adjustable) if a person delay to access.
- **ANTI-PASS BACK** The gate will stay in lock if someone wants to entry in the reverse direction.
- **ANTI-INTRUSION** The gate is locked automatically until a valid open signal is sent.
- **FAST UNLOCK** One there is a valid signal, the gate will unlock within 0.2s (adjustable) .
- **HIGH PERFORMANCE** Long-life performance, high operation dependability and fast response.
- **HIGH MECHANISM** Full height mechanism, running smoothly and stable
- **ALARM FUNCTION** Infrared sensor alarm function, in case of illegal intrusion and reverse intrusion.

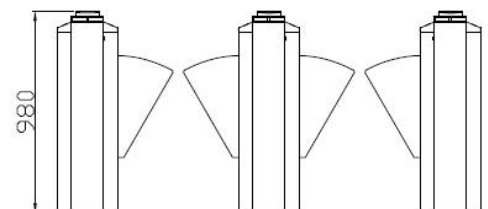
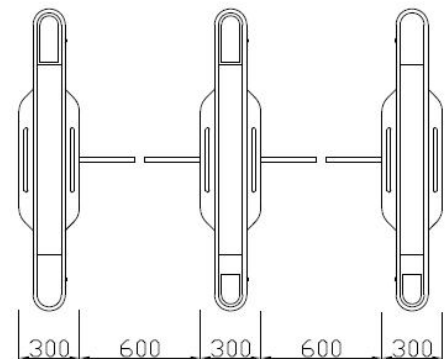
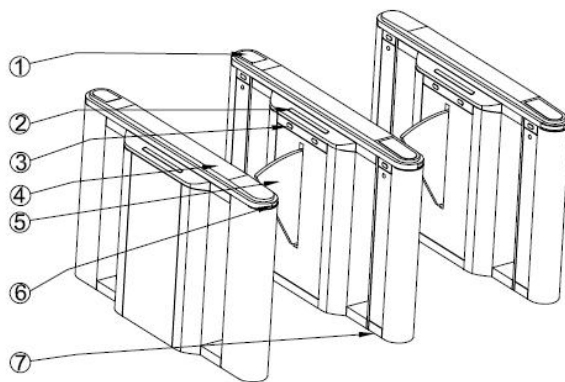

- ① Acrylic CARD Window
- ② Lane Status Indicator
- ③ IR Sensor Cover
- ④ Stainless Steel Top Lid
- ⑤ Acrylic flap arm
- ⑥ LED RGB
- ⑦ Position of Fixing Screw

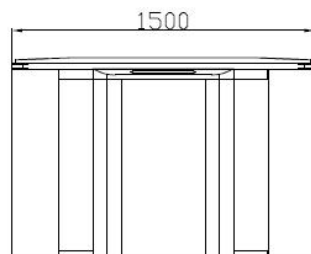

Customization

- Dimension: Can be made according to the client's site.
- Optional dual-layer retractable flap arm with a passing width of up to 900 mm (for wheelchairs and luggage).
- Flap arm color: Transparent color, blue and red available.
- Material: 304 stainless steel to 316 stainless steel (wet environment), or iron with powder coated (color can be customized).
- Lights and infrared sensors can be added.
- Mounting base (for above floor wiring) and removable base (for temporary events) can be added.
- Cutouts can be customized to fit any reader.
- LOGO can be customized.
- Customized 3D drawings are available based on the site photos.
- OEM& ODM service is available.

Access control system

Our gates come with relay signals and RS485/RS232 interfaces. You can use your own access control system, or we can provide a complete access control system to you.

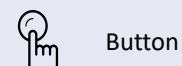
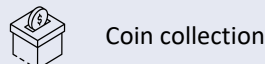
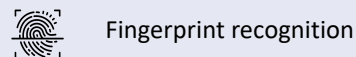
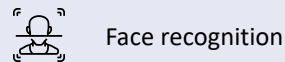
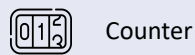
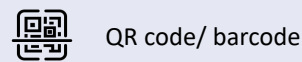
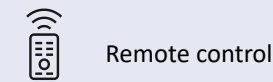

We also offer customization services.

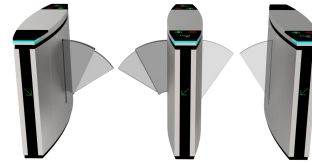

Dual-layer retractable flap arms



Blue flap arms

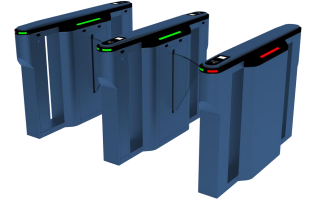

Other frame colors available, RAL or RGB required.



Mounting base

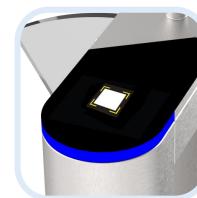
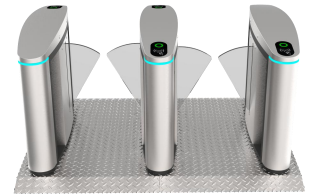

Cutouts can be customized to fit any reader.



LOGO can be customized.



Emergency mode



Powered of equipment
with Super Capacitor Backup

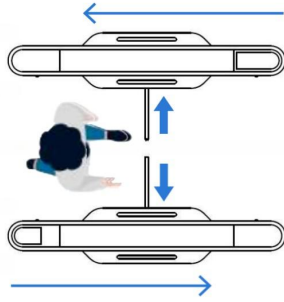

In case of a power outage,
obstacles are unlocked
and automatically open in
the direction of egress.

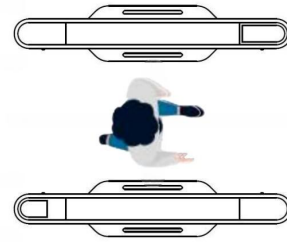

Obstacles are locked in
the open position so as
not to interfere with the
evacuation process.

Lane combination

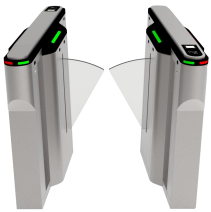

One lane

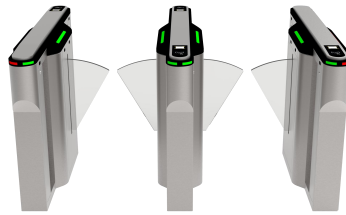

Two lanes

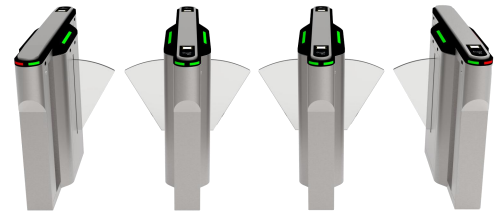

Three lanes

