

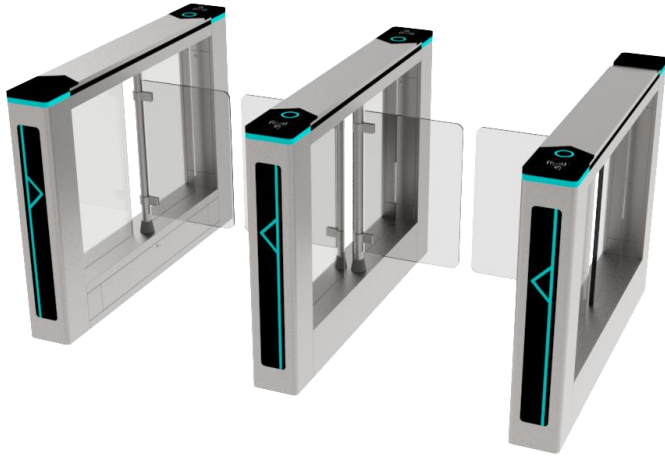

SLIM SWING TURNSTILE MT360

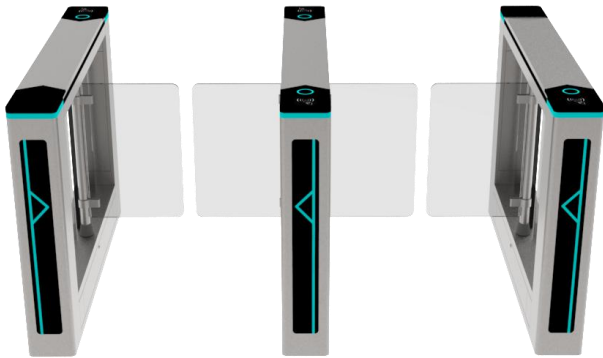

The **MT360 glass swing turnstile** open or close the passage with two swing arms. The swing arm will be opening in the same direction. These gates are characterized by their slender, compact design, making them suitable for locations where space is at a premium or where aesthetics are a consideration. The swing gates can be customized in terms of design, color, and material to match the surrounding architecture and meet specific aesthetic preferences.



The glass swing gates are designed with security in mind. They have features like anti-tailgating technology, which prevents unauthorized individuals from following closely behind an authorized user to gain entry. Some models also include alarms or indicators to alert security personnel to suspicious activity.

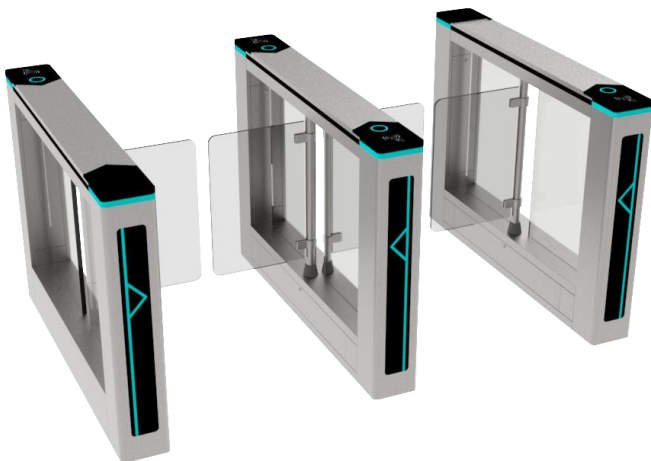

Swing gates can be single-leaf (a single gate panel) or double-leaf (two gate panels that swing open in opposite directions). The choice between single and double swing gates depends on factors like the width of the entrance and the desired aesthetic.



PASSING SPEED



PASSAGE FOR DISABLE



BI-DIRECTION



110V-220V
POWER SUPPLY



ANTI-TAILGATING



PROTECTIVE LEVEL

Technical Specifications

Dimension	1400*185*1020mm (4.59*0.61*3.35ft) (standard)
Material	SUS 304
Swing arm Material	Acrylic/ Tempered glass
Passage Width	600mm (1.97ft) -900mm(2.95ft)
Passage direction	Unidirectional/Bi-directional
Mechanism	DC Brushless Motor
Pass rate	40 persons/minute
Operating time	0.2 seconds
Power Supply	100V-240V 50/60Hz
Radar for automatic open	Unidirectional/Bi-directional
Open Signal	Passive Relay (Dry Contact)
Communication	RS485/RS232
MCBF	3,000,000 Cycles
Working Temperature	-40°C ~ 70°C
Working Environment	Indoor
Relative Humidity	95% Maximum

Feature

- **LED ALERTS** Indicate traffic direction with highly-visible green and red. The top LED will keep green arrow shows that the lane is available. The LED on the side will change based on the status of the gates.
- **LANE STATUS LED** If the access is granted, the LED will be in green. In standby, the LED is blue. If denied access, the LED flash red.
- **ALARM FUNCTION** Infrared sensor alarm function, in case of illegal intrusion and reverse intrusion.
- **EMERGENCY EXIT** The function allows free passage in the event of an emergency or power outage, automatic reset when power is restored.
- **WORKING DIRECTION** Single directional or Bi-directional is optional.
- **AUTOMATIC RESET** The swing arms will lock automatically within 5s (adjustable) if a person delay to access.
- **ANTI-COLLISION** When the gates instantaneously encounter an impulse force that is beyond the safety range, the arm will automatic reset in place. The mechanism will not be damaged at all.
- **ANTI-PASS BACK** The gate will stay in lock if someone wants to entry in the reverse direction.
- **ANTI-TRAILING** The gate will alarm if more than one person passby without permission.
- **ANTI-INTRUSION** The gate is locked automatically until a valid open signal is sent. When there is a valid signal, the gate will unlock within 0.2s (adjustable) .

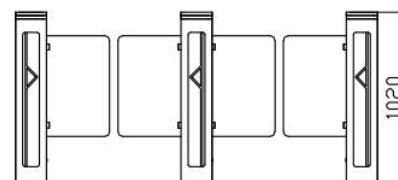
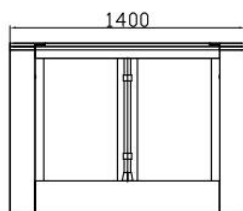
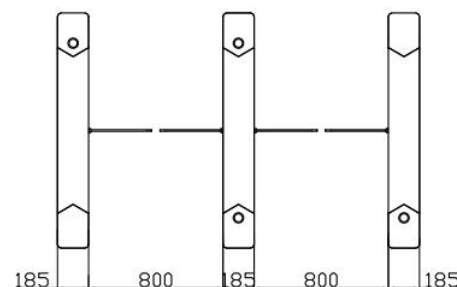
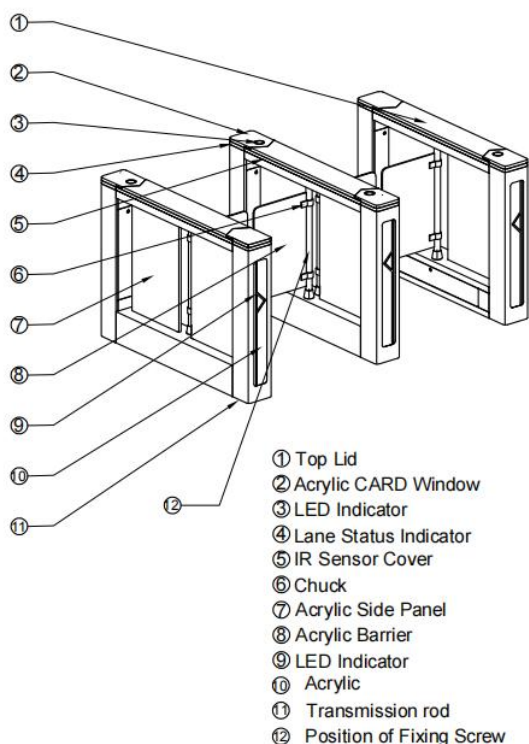

Customization

- Dimension: Can be made according to the client's site.
- Material: 304 stainless steel to 316 stainless steel, or iron with powder coated (color can be customized).
- Swing arm material available in glass or acrylic.
- Swing arm LED optional. The arms are more visible in the dark.
- Lights and infrared sensors can be added.
- Mounting base (for above floor wiring) and removable base (for temporary events) can be added.
- Cutouts can be customized to fit any reader. Swipe card icon can be cancelled
- LOGO can be customized.
- Customized 3D drawings are available based on the site photos.
- OEM& ODM service is available.

➤ Please check with sales for customization fees.

Access control system

Our gates come with relay signals and RS485/RS232 interfaces. You can use your own access control system, or we can provide a complete access control system to you.



Remote control



RFID card



QR code/ barcode



Counter



Face recognition



Fingerprint recognition



Coin/Card collection



Button

We also offer customization services.



Cutouts can be customized to fit any reader.



LOGO can be customized.

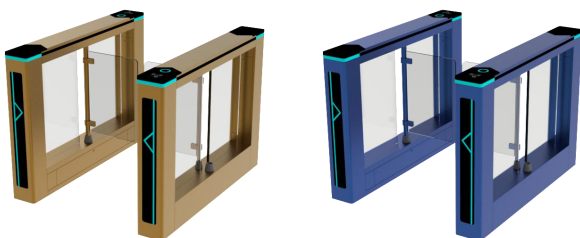

Other frame colors available, RAL or RGB required.

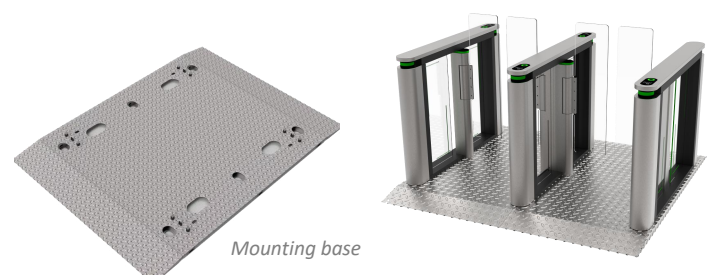

Mounting base



Emergency mode



Powered of equipment
with Super Capacitor Backup

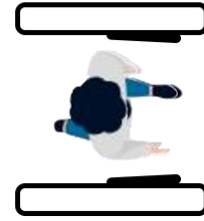
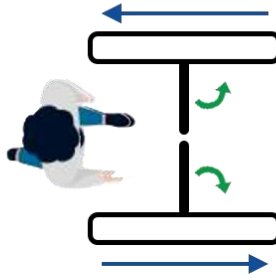

In case of a power outage, swing arms are unlocked
and open automatically.

Lane combination



One lane



Two lanes



Three lanes

